



NISSAN X-TRAIL

2014-

Cat. No. **N/053**

E20 E20 55R-01 4952

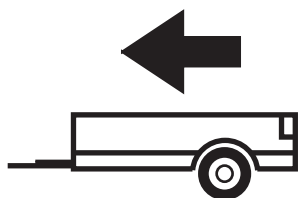

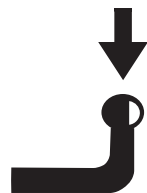

2200kg



110kg

D = 11,10kN

$$D \text{ (kN)} = \frac{\text{MAX kg} \times \text{MAX kg}}{\text{MAX kg} + \text{MAX kg}} \times 0,00981$$

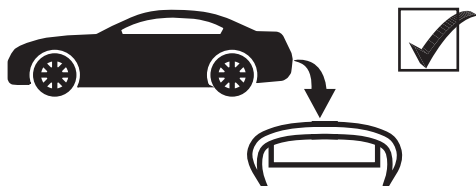



IMIOLA HAK-POL

96-111 KOWIESY, CHOJNATA 23A, POLAND

Tel. + 48 46 831 73 31, fax +48 831 74 29

e-mail: office@imiola.pl, www.imiola.pl

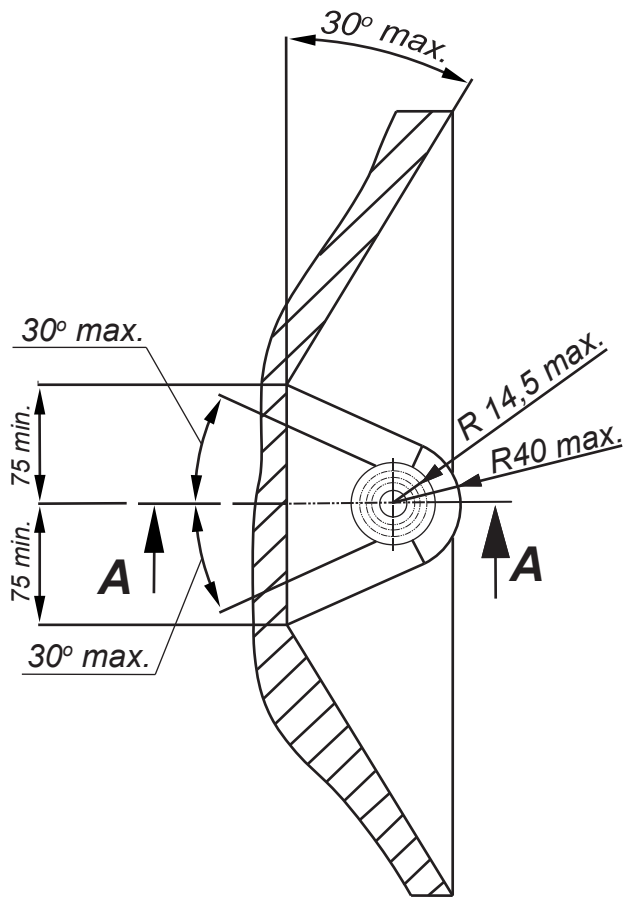

PRZEKRÓJ A-A

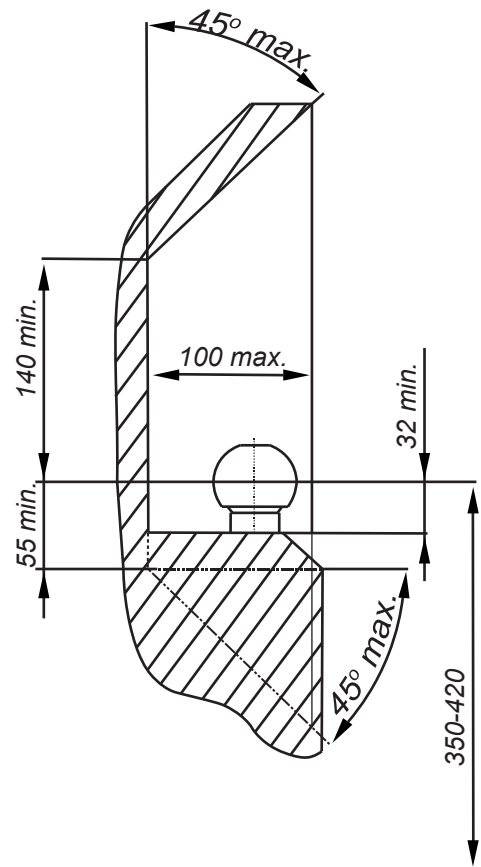

PL Należy zagwarantować przestrzeń swobodną według załącznika VII, rysunek 25a/b Regulaminu EKG ONZ 55.01 przy dopuszczalnym ciężarze całkowitym pojazdu.

F L'espace libre doit être garanti conformément à l'annexe VII, illustration de la réglementation 55.01 CE pour un poids total en charge autorisé du véhicule.







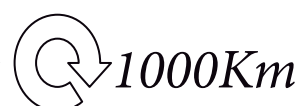

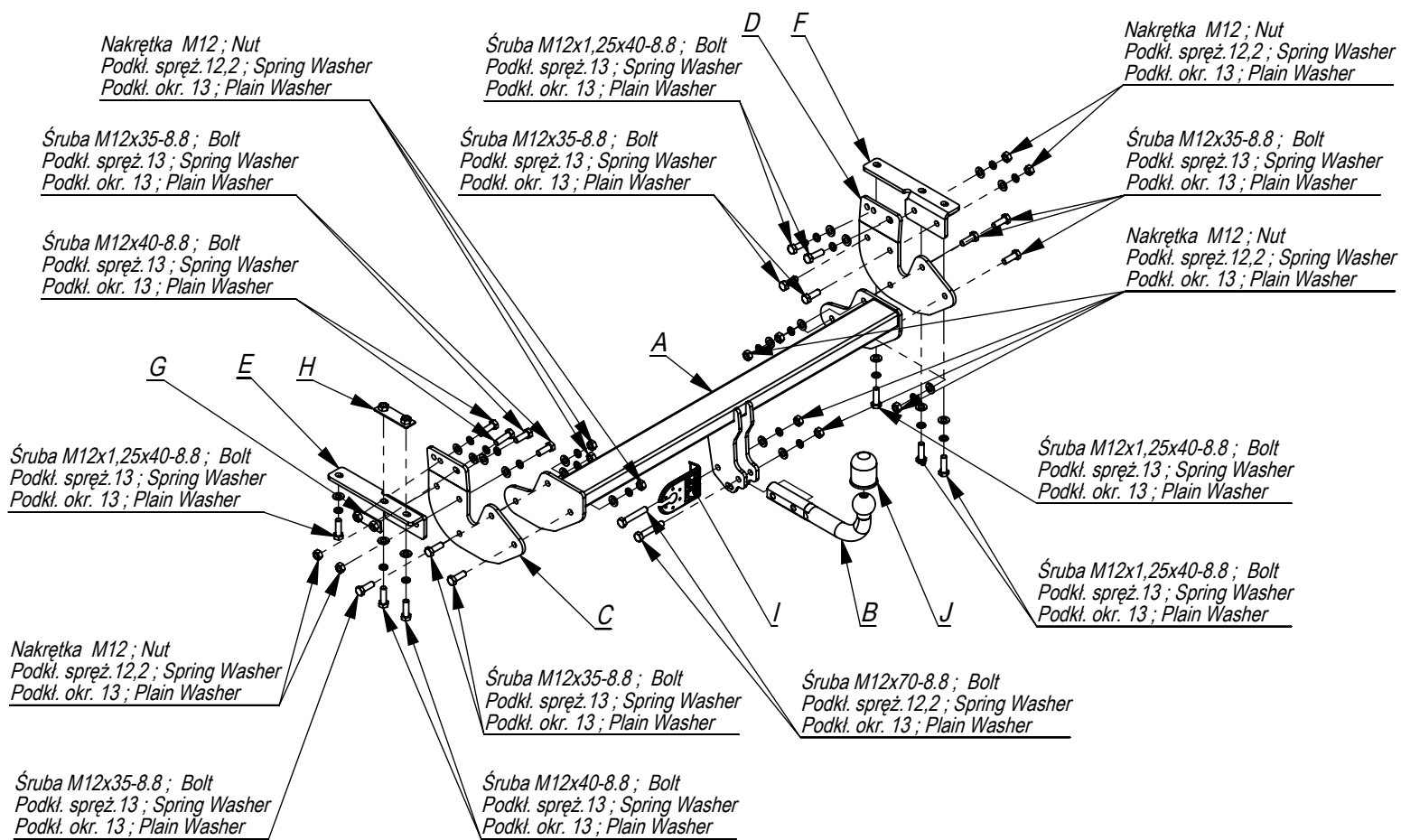

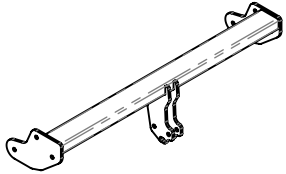
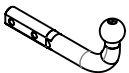

GB The clearance specified in appendix VII, diagram 25a/b of Regulation No. 55.01 UN EU must be guaranteed at laden weight of the vehicle.

D Der Freiraum nach Anhang VII, Abbildung 25a/b der Vorschriften 55.01 EG ist zu gewährleisten bei zulässigem Gesamtgewicht des Fahrzeuges.

Moment skrczący dla śrub i nakrętek (8.8) Torque settings for nuts and bolts (8.8)	
M8	25Nm
M10	55Nm
M12	85Nm
M14	135Nm
M16	195Nm





	A	x1		M12x70	2		
				M12x40	4		
				M12x1,25x40	6		
				M12x35	10		
	C	x1		M12	12		
	D	x1			13	22	
	E	x1				12,2	22
	F	x1					
	G	x1					
	H	x1					
	I	x1					
	J	x1					

- Odkręcić zderzak .
- Odkręcić ucho holownicze, belkę zderzeniową - nie będą już wykorzystane.
- Elementy C i D przykręcić lekko do podłużnicy wraz z elementami E i F śrubami M12x40 8.8 (pkt 2 i 3) oraz śrubami M12x40x1.25 (pkt4) stosując nakładki G i H .
- Belkę haka A przykręcić śrubami M12x35 8.8 (pkt 1)
- Wykonać w zderzaku wycięcie na łapki kuli.
- Zamontować zderzak.
- Dokręcić wszystkie śruby z momentem według tabeli.
- Dokręcić kulę i blachę gniazda elektrycznego.
- Podłączyć instalację elektryczną.

- Unscrew the bumper.
- Unscrew the towing eye and bumper bar (they will not be used any more).
- Screw slightly the elements C and D to the frame side member together with the elements E and F with bolts M12x40 8.8 (point 2 and 3) and with bolts M12x40x1,25 (point 4) using plates G and H.
- Screw the main bar A with bolts M12x35 8.8 (point 1).
- Cut out the fragment in the bumper to place the handles of the ball.
- Screw the bumper.
- Tighten all the bolts according to the torque setting- see the table.
- Fix the ball and electric plate.
- Connect the electric wires.

- Dévisser le pare-chocs.
- Dévisser l'anneau d'attelage, la poutre de pare-chocs - il ne seront plus utilisés.
- Serrer légèrement les éléments C et D contre le longeron avec les éléments E et F, avec les boulons M12x40 8.8 (pts 2 et 3) et les boulons M12x40x1.25 (pt 4), en utilisant les protections G et H.
- Visser la barre de crochet A avec les vis M12x35 8.8 (pt 1)
- Ouvrir l'axe de pare-chocs en partie basse.
- Installer le pare-chocs.
- Serrer tous les boulons avec un couple de serrage selon tableau.
- Serrer la boule et la tôle de la prise électrique.
- Brancher l'installation électrique.

- Den Stoßfänger abschrauben.
- Schrauben Sie die Abschleppöse, den Aufprallträger ab - sie werden nicht mehr benutzt.
- Die Elemente C und D zusammen mit den Elementen E und F mit den Schrauben M12x40 8.8 (Pkt. 2 und 3) und den Schrauben M12x40x1.25 (Pkt. 4) mit den Abdeckungen G und H leicht am Längsträger befestigen.
- Den AHK-Träger A mit Schrauben M12x35 8.8 (Punkt 1) anschrauben.
- In der Stoßstange einen Ausschnitt für die Klappen der Kugel ausführen.
- Montieren Sie die Stoßstange.
- Ziehen Sie alle Schrauben mit dem Drehmoment gemäß der Tabelle an.
- Die Kugel und den Steckdose-Blech anziehen.
- Die elektrische Installation anschließen.

- Desenroscar el parachoques.
- Desenrosque la argolla de remolque, la viga de impacto - ya no se usarán.
- Fijar ligeramente los elementos C y D al elemento longitudinal junto con los elementos E y F con los pernos M12x40 8.8 (puntos 2 y 3) y los pernos M12x40x1.25 (punto 4) utilizando las overlays G y H.
- Apretar la barra del gancho A com tornillos M12x35 8.8 (punto 1).
- Hacer un corte en el parachoques para las garras de la bola.
- Instalar el parachoques.
- Apretar todos los tornillos con el par según la tabla anterior.
- Apretar la bola y la placa de la toma eléctrica.
- Conectar la instalación eléctrica.

