

2

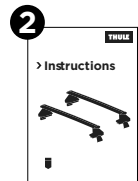

> Instructions

Thule Evo Clamp
7105

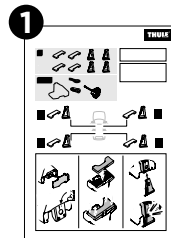
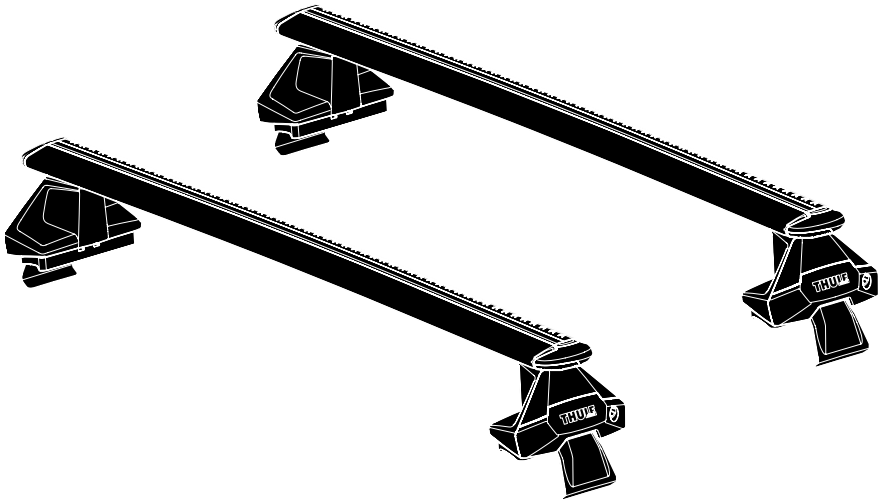

EN Roof mounted load carrier
 DE Lastenträger zur Dachmontage
 FR Barre de toit
 NL Dakdrager
 IT Barra portatutto da installare sul tetto
 ES Portaequipajes de techo
 PT Barra para montagem no tejadilho
 SV Takmonterad lasthållare
 DK Tagmonteret lastholder
 NO Takmontert lasteholder
 FI Katolle asennettava teline
 ET Katusele paigaldatav katuseraam
 LV Uz jumta uzstādāms kravas turētājs
 LT Ant stogo tvirtinamas krovinijų laikiklis
 PL Uchwyt na bagażnik bazowy montowany na dachu
 RU Багажник на крышу
 UK Багажник для даху
 BG Багажник, монтиран върху покрива
 CS Nosič pro montáž na střechu
 SK Strešný nosič
 SL Nosilec za strešni prtljažnik

HR/BIH Krovni nosač tereta
 RO Suport încărcătură montat pe acoperiș
 HU Tetőre szerelhető csomagszállító
 EL Σχάρα οροφής για μεταφορά φορτίου
 TR Araç üstüne bağlanan yük taşıyıcı

HE מנשא מטען לגג הרכב
 AR حامل نقل مثبت على السقف

ZH 顶置行李架
 JA ルーフマウント型ロードキャリア
 KO 루프 장착 화물 캐리어
 TH โครยัดของบรรทุกแบบติดตั้งบนหลังคา

CITY CRASH

Complies with ISO norm

ISO 11154-E

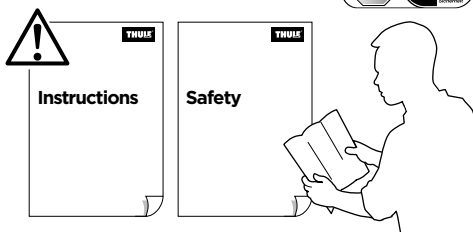

> Mounting Tutorial

Thule Evo Clamp

THULE
SWEDEN

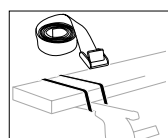
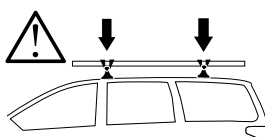
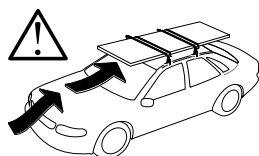

1
KIT

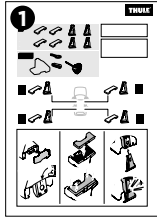

+

2
FOOT PACK

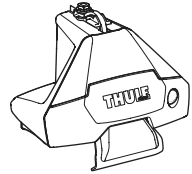
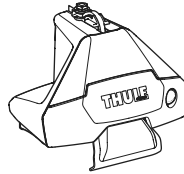
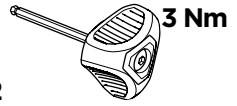
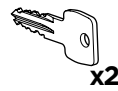
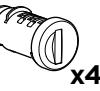
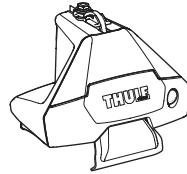
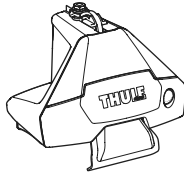
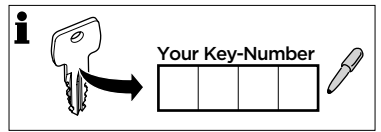
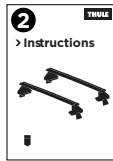

3
BAR



THULE
WingBar Evo

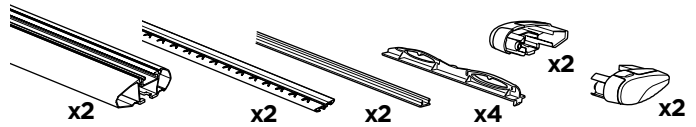

THULE
WingBar

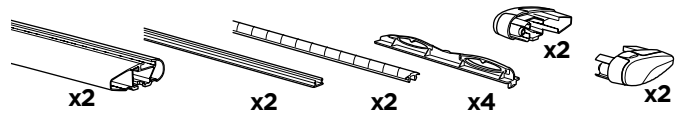

THULE
SlideBar

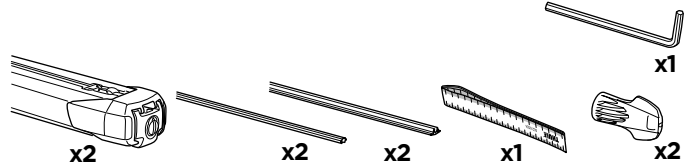

THULE
ProBar

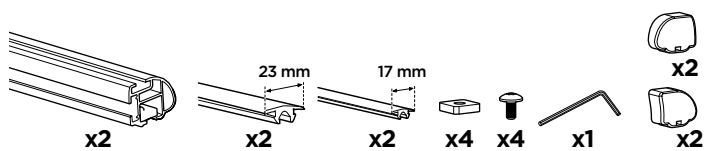

THULE
SquareBar

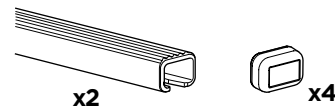

4

BAR

3

THULE
WingBar Evo

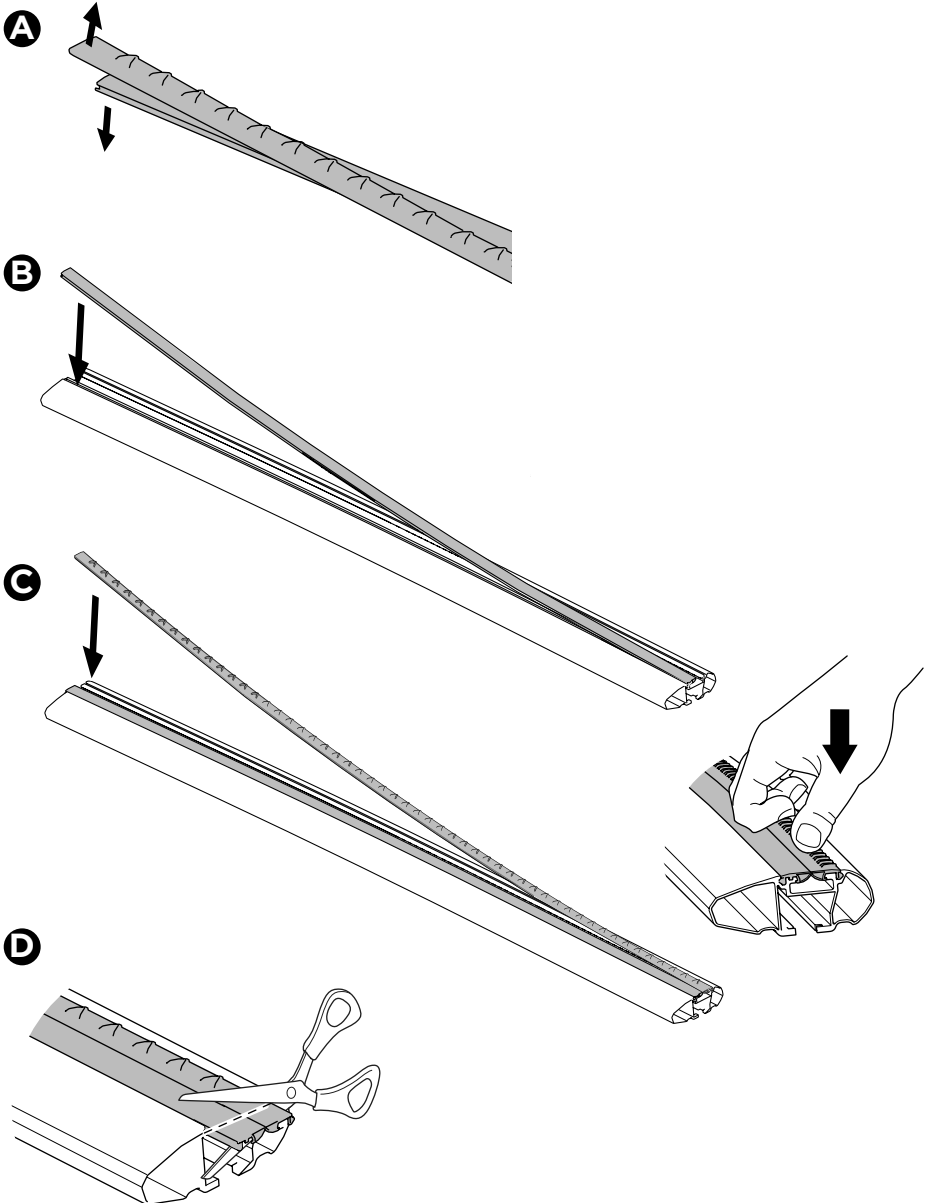

x2

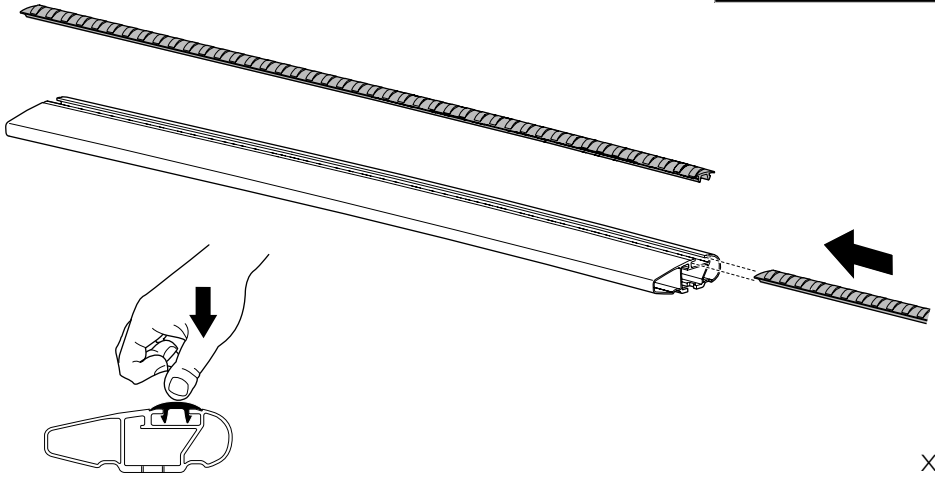

5



A

B

C

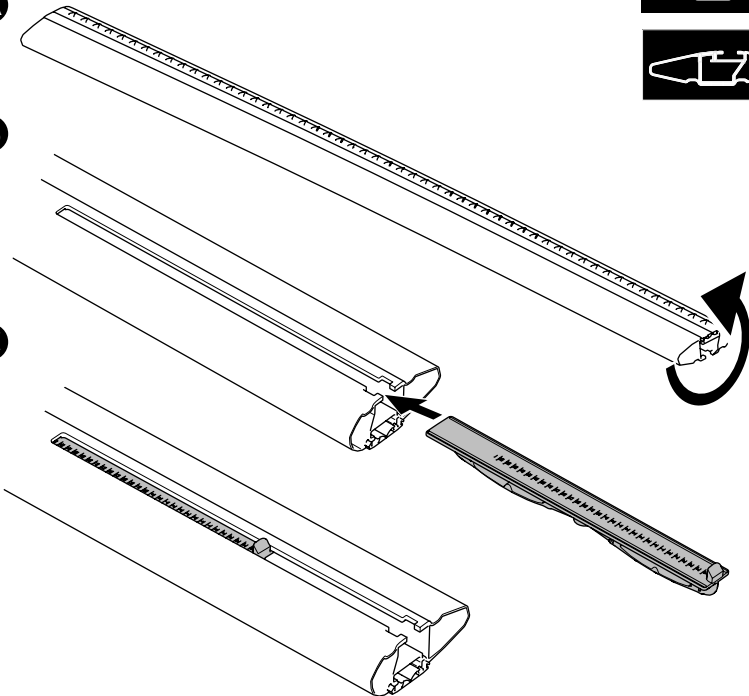

6



+



+

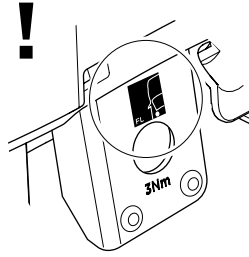
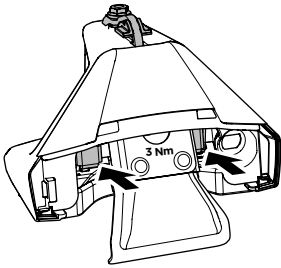

A

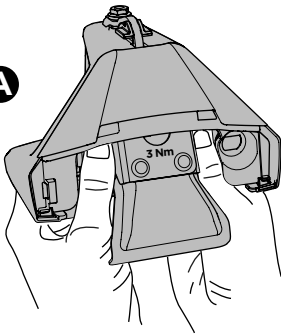

B

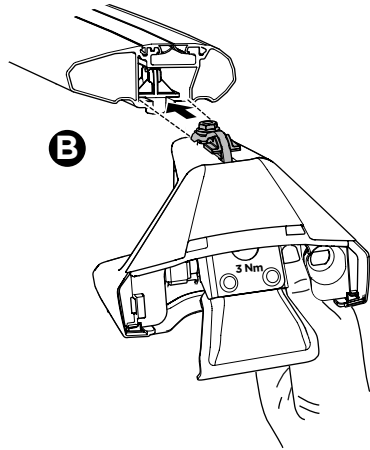

x4

7

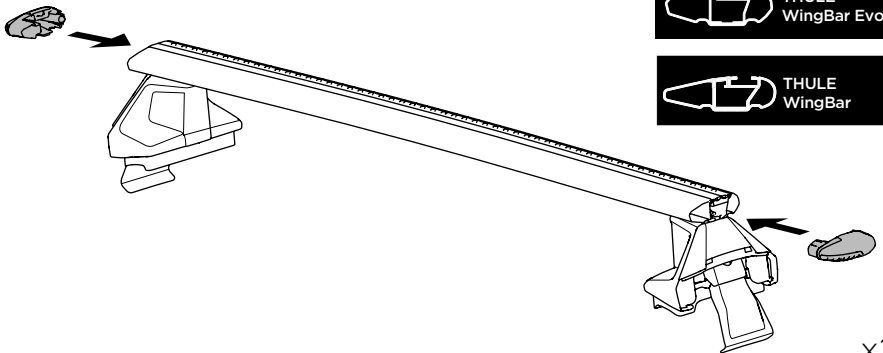

x2

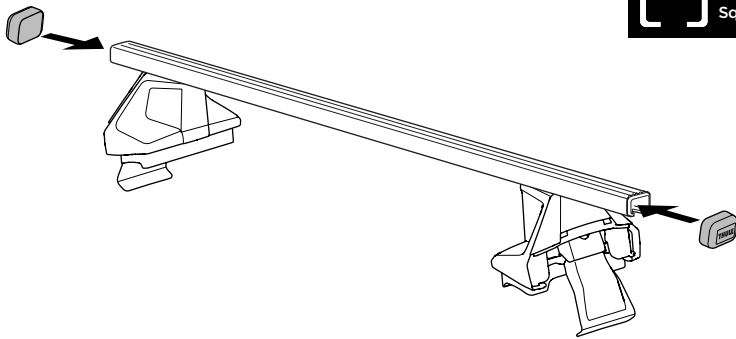

 THULE
SquareBar

x2

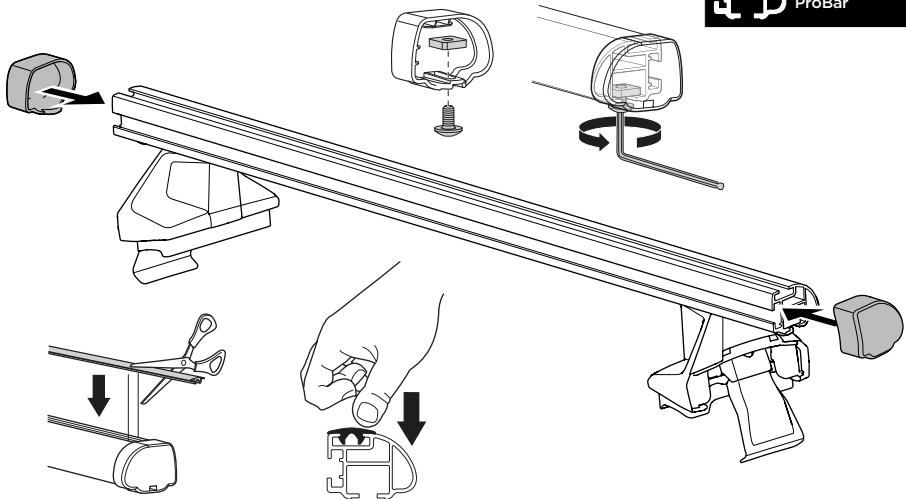

 THULE
ProBar

x2

 THULE
SlideBar

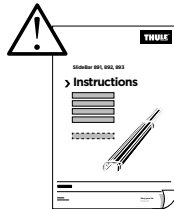
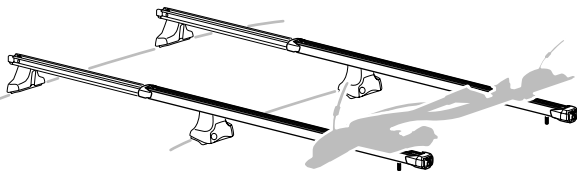

8

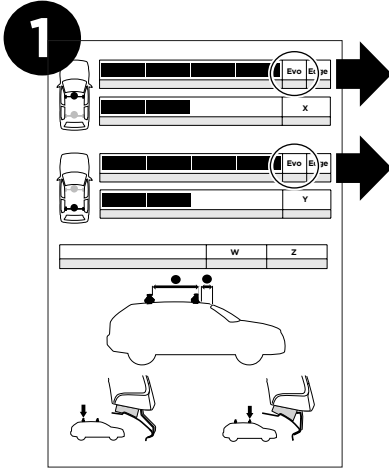
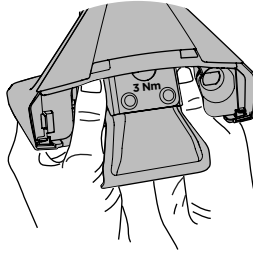

X / Y Scale

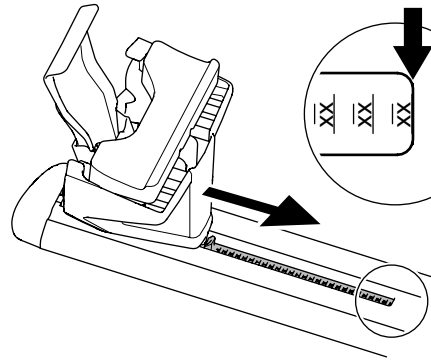
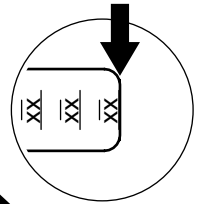

x4

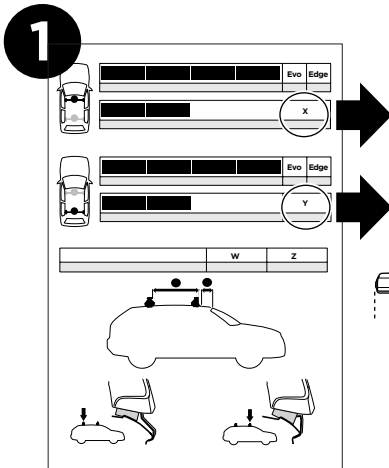
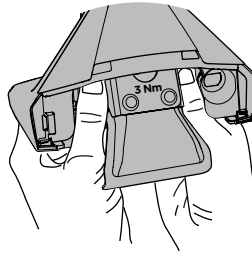

X / Y (mm / inch)

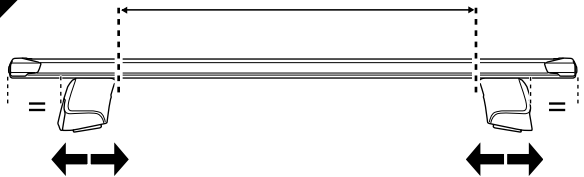

x2

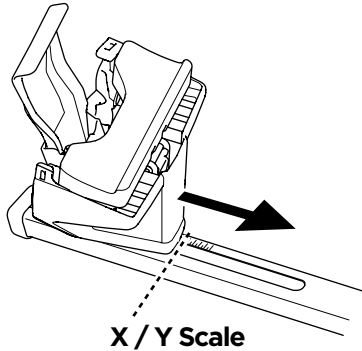
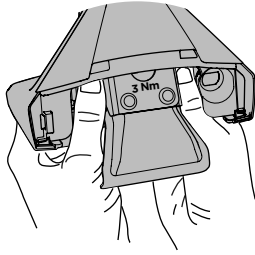
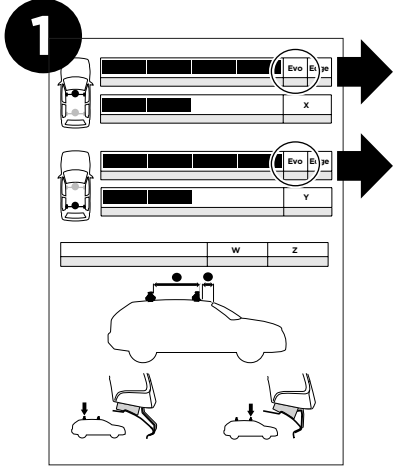

x4

9

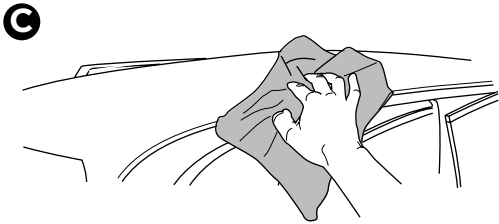
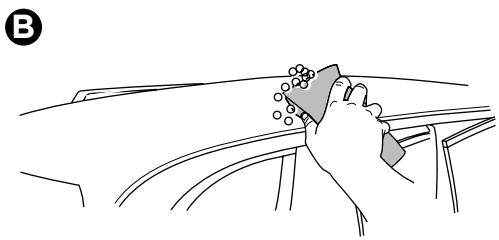
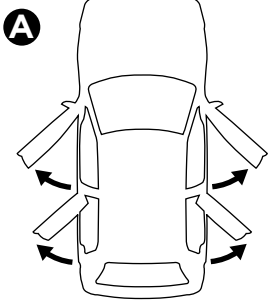

10

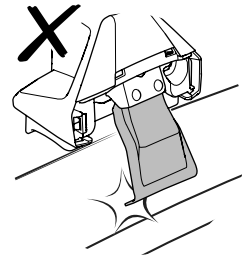
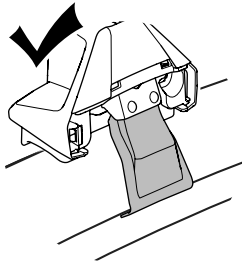
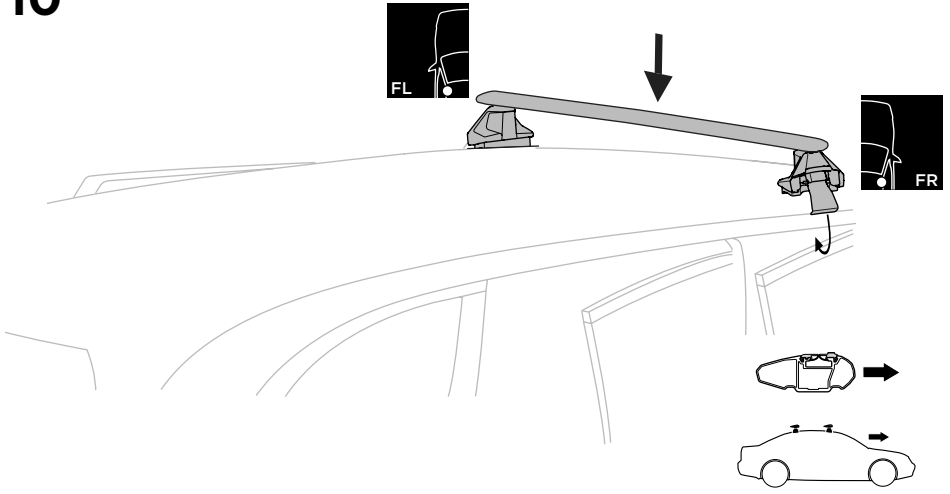

1

	Evo Edge
	X

	Evo Edge
	Y

	W	Z
--	---	---

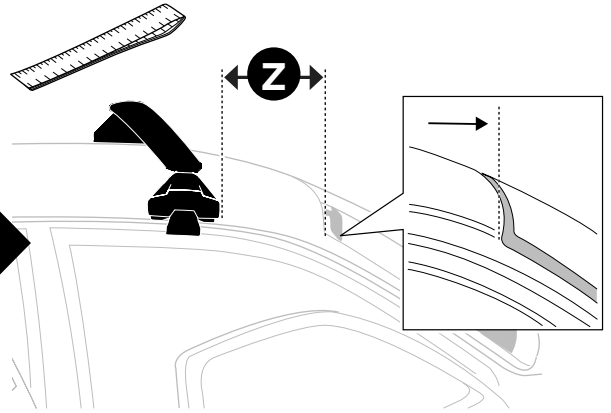

11

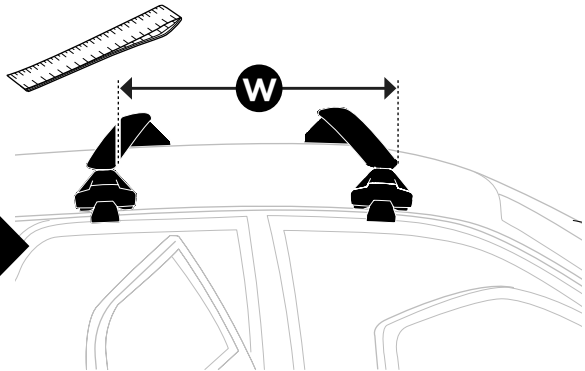
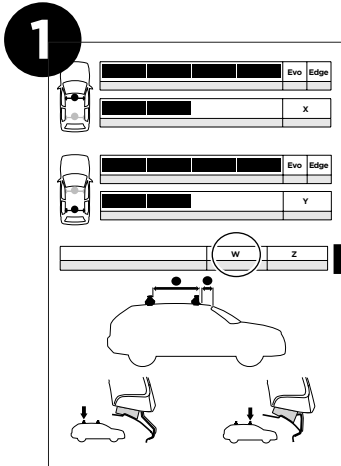
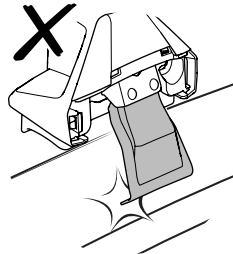
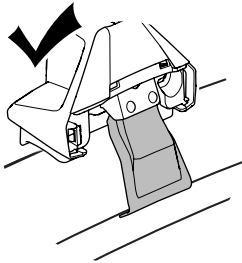
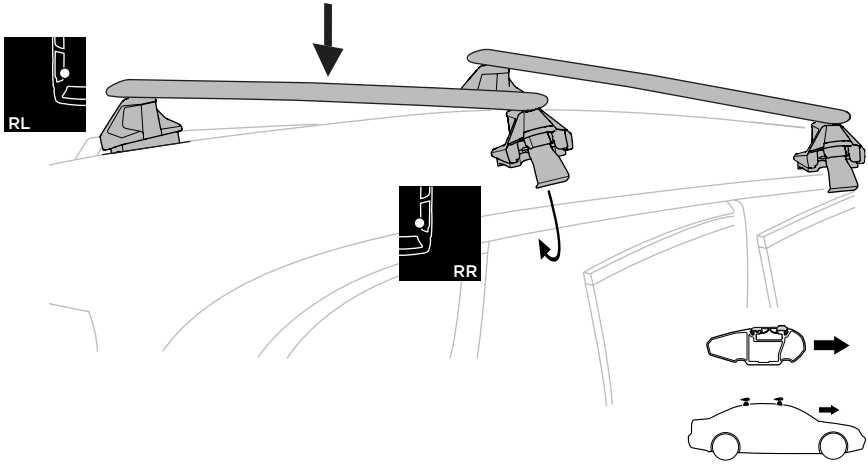

12

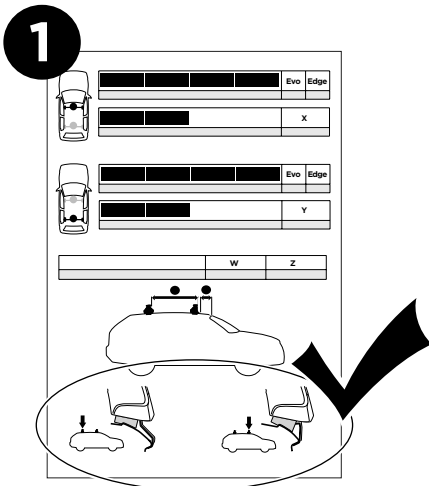
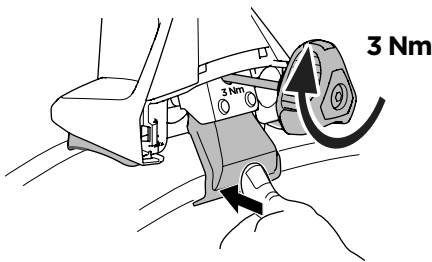
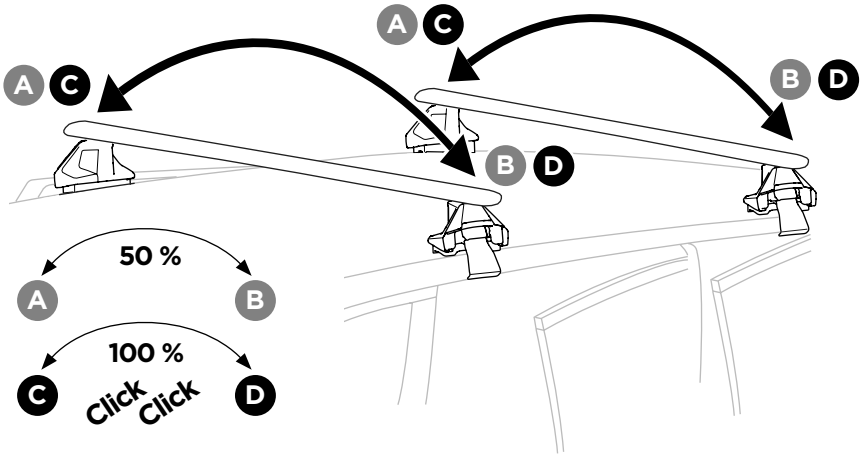

- EN** Tighten alternately
DE Die Schrauben abwechselnd anziehen
FR Serrer alternativement chaque côté
NL Afwisselend aan de linker- en de rechterkant aandraaien
IT Alternare il serraggio delle viti
ES Apretar alternativamente
PT Aperte alternadamente
SV Dra åt växelvis
DK Spænd skiftevis
NO Trekk til vekselvis
FI Kierrä vuorotellen
ET Pinguldage vaheldumisi
LV Pievelciet pamišus
LT Užsukinėkite pakaitomis
PL Śruby dokręcaj naprzemiennie
RU Затягивайте попеременно
UK Затягти почергово
BG Затегнете последователно
CS Pokręťta багаžníka dokręcaj dokręcaj naprzemiennie.
SK Doťahujte striedavo
SL Privijajte izmenično
HR/BiH Naizmjenično zategnite
RO Strângeți alternativ
HU Egy mástól függetlenül szorítandó
EL Σφιγγετε εναλλάξ
TR Dönüşümlü sıkın

إحكام الربط بالتناوب **AR**
 תזק לסירוקן **HE**

- ZH** 交替拧紧
JA 左右交互に締めつけてください
KO 번갈아 조이기
TH ขั้นในแบบสลับ

13

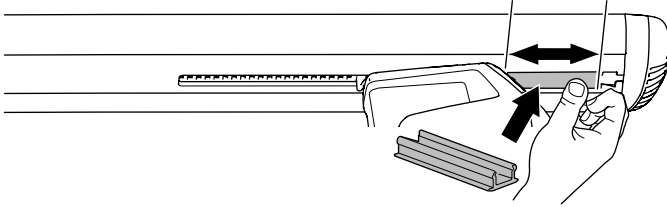
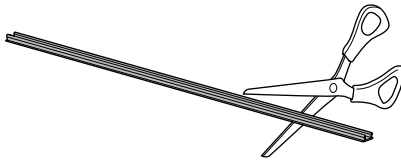

x4

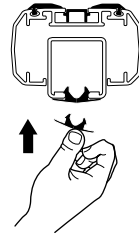
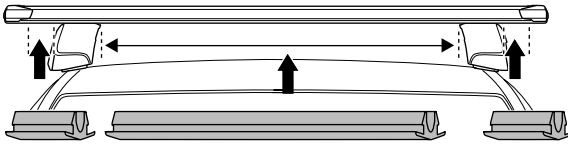
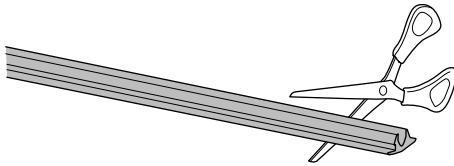

x2

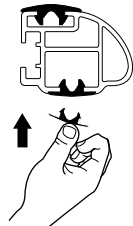
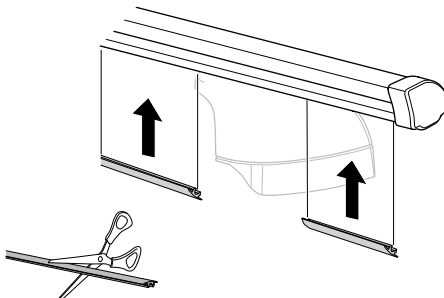
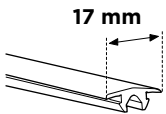

x2

14

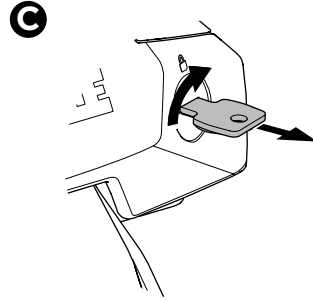
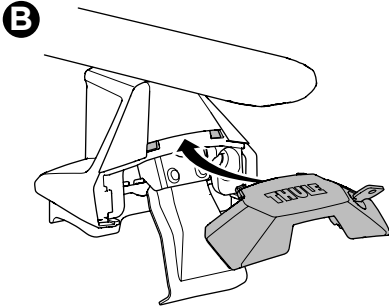
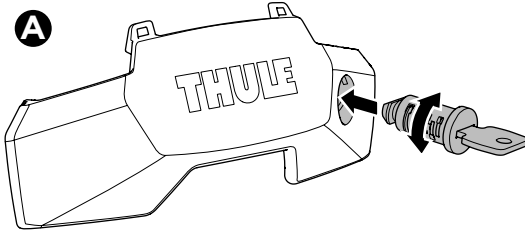

x4

15

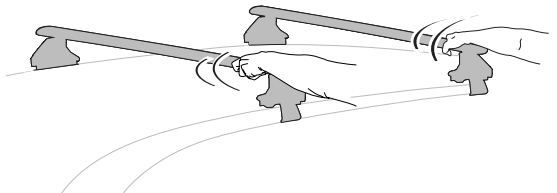
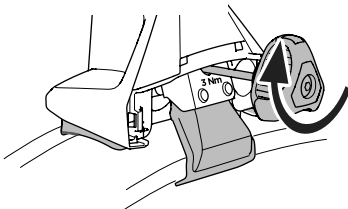
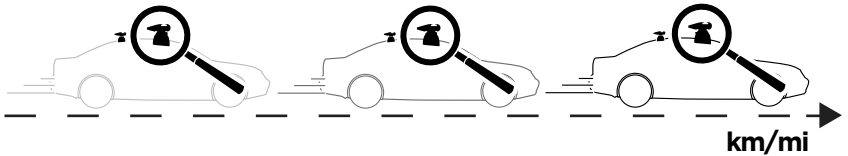
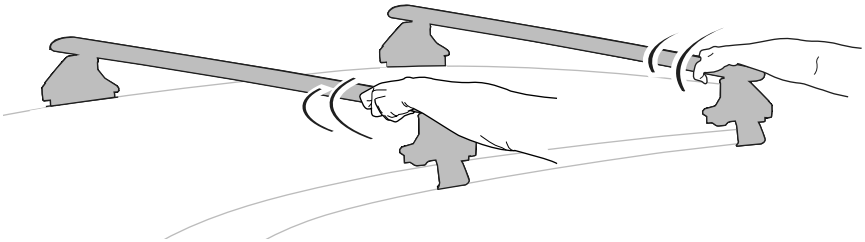

i



THULE
WingBar Evo

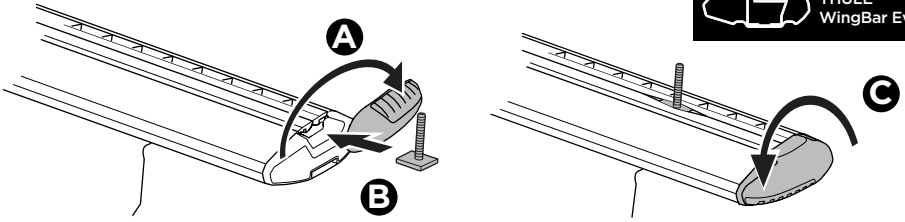

THULE
WingBar

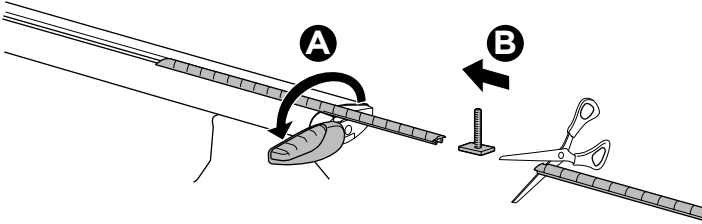

THULE
SlideBar

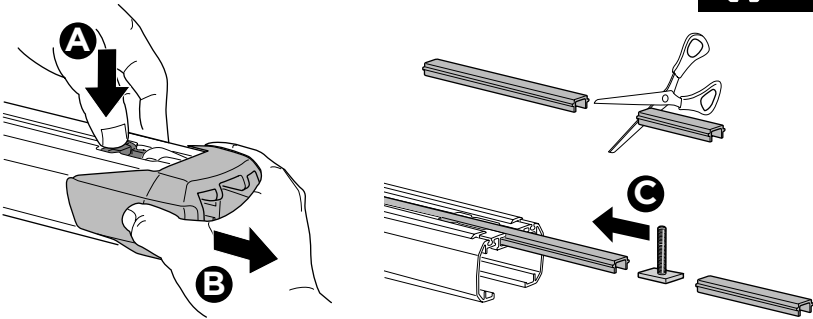

THULE
ProBar

