

## FITTING INSTRUCTION

Clamp mark in acc. with		Cables joining
ISO	PN	
1	L	Left directional lights
2	+	Rear fog lights
3	31	Ground
4	R	Right directional lights
5	58R	Right side parking lights
6	54	Stoplights
7	58L	Left side parking lights

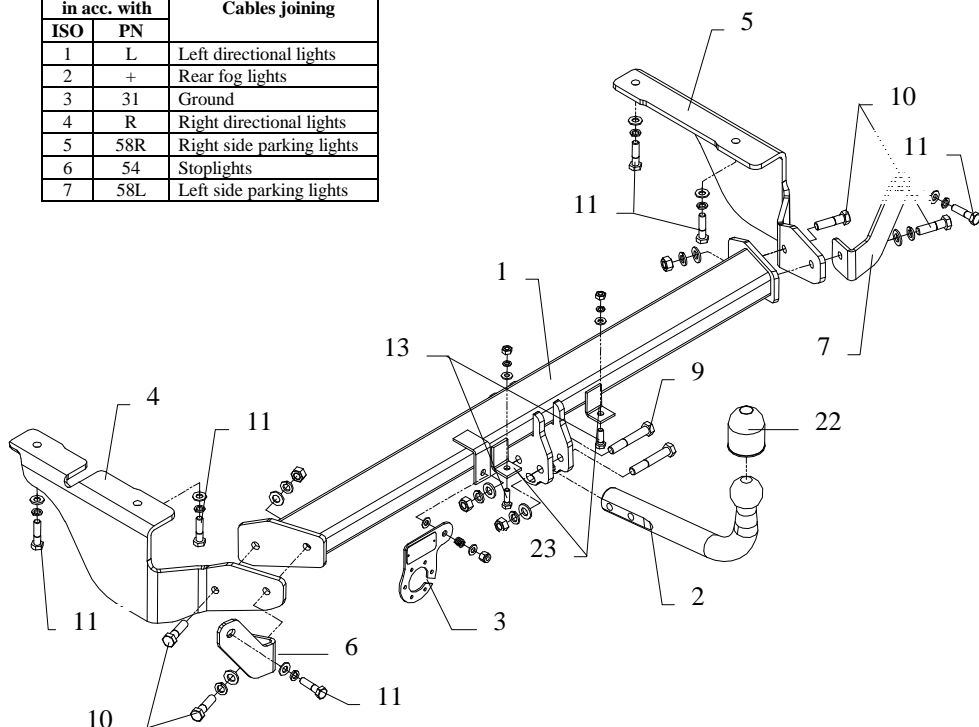

This towbar is designed to assembly in following cars:

**CITROEN C5 I ESTATE**, produced since 10.2004 till 03.2008, catalogue no. **P30** and is prepared to tow trailers max total weight **1600 kg** and max vertical load **85 kg**.

### *From manufacturer*

Thank you for buying our product. Their reliability has been confirmed in many tests. Reliability of towbar depends also on correct assembly and correct exploitation. For this reasons we kindly ask to read carefully this instruction and apply to hints.

*The towbar should be install in points described by a car producer.*

## The instruction of the assembly

1. Underneath of the bumper unfix plastic spoiler (not used any more).
2. In original prepared points fix loosely side brackets (pos. 4 and 5) using bolts M10x40mm (pos. 11).
3. Slip main bar of the towbar (pos. 1) between side brackets and fix it by bolts M12x45mm (pos. 10). Remember about angle elements (pos. 6 and 7).
4. To handles pos. 23 fix the bumper by bolts M8x25mm (pos. 13).
5. Fix tow-ball (pos. 2) using bolts M12x75mm (pos. 9) from accessories and socket plate (pos. 3) by bolts M8x30 mm according to the drawing.
6. Tighten all bolts according to the torque shown in the table.
7. Connect electric wires of 7-poles socket according to the instruction of the car. (Recommend to make at authorized service station)
8. Complete paint layer damaged during installation.

Torque settings for nuts and bolts (8,8):

<b>M6</b> - 11 Nm	<b>M8</b> - 25 Nm	<b>M10</b> - 50 Nm
<b>M12</b> - 87 Nm	<b>M14</b> - 138 Nm	<b>M16</b> - 210 Nm











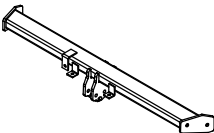
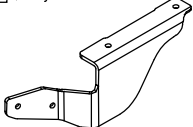

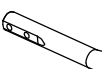





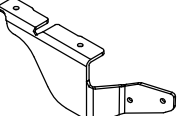

## NOTE

After install the towbar you should get adequate note in registration book (at authorised service station).The car should be equipped with:

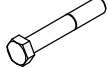
- Indicators
- Tow mirrors

After 1000km of exploitation check all bolts and nuts. The ball of towbar must be always kept clear and conserve with a grease.

## Towbar accessories:

Pos. 1 Name: Main bar Quantity: 1 	Pos. 5 Name: Right bracket Quantity: 1 	Pos. 10 Name: Bolt 8,8 B Quantity: 4 Dim.: M12x45mm 	Pos. 16 Name: Plain washer Quantity: 6 Dim.: Ø 13 mm 
Pos. 2 Name: Tow ball Quantity: 1 	Pos. 6 Name: Right side bracket Quantity: 1 	Pos. 11 Name: Bolt 8,8 B Quantity: 6 Dim.: M10x40mm 	Pos. 17 Name: Plain washer Quantity: 6 Dim.: Ø 10,5 mm 
Pos. 3 Name: Socket plate Quantity: 1 	Pos. 7 Name: Left side bracket Quantity: 1 	Pos. 12 Name: Bolt 8,8 B Quantity: 1 Dim.: M8x30mm 	Pos. 18 Name: Plain washer Quantity: 4 Dim.: Ø 8,5 mm 
Pos. 4 Name: Left bracket Quantity: 1 	Pos. 8 Name: Spring Quantity: 1 	Pos. 13 Name: Bolt 8,8 B Quantity: 2 Dim.: M8x25mm 	Pos. 19 Name: Spring washer Quantity: 6 Dim.: Ø 12,2 mm 
	Pos. 9 Name: Bolt 8,8 B Quantity: 2 Dim.: M12x75mm 	Pos. 14 Name: Nut 8 B Quantity: 4 Dim.: M12 	Pos. 20 Name: Spring washer Quantity: 6 Dim.: Ø 10,2 mm 
	Pos. 15 Name: Nut 8 B Quantity: 3 Dim.: M8 	Pos. 21 Name: Spring washer Quantity: 2 Dim.: Ø 8,2 mm 	
		Pos. 22 Name: Ball cover Quantity: 1 	



**PPUH AUTO-HAK Sp.J.**

Produkcja Zaczepów Kulowych  
Henryk & Zbigniew Nejman  
76-200 SŁUPSK ul. Słoneczna 16K  
tel/fax (059) 8-414-414; 8-414-413  
E-mail: office@autohak.com.pl  
www. autohak.com.pl

## Towing hitch (without electrical set)

Class: **A50-X** Cat. no. **P30**

Designed for:

Manufacturer: **CITROEN**

Model: **C5 I**

Type: **ESTATE**

Technical data:

**D-value: 8,99 kg**

maximum trailer weight: **1600 kg**

maximum vertical cup load: **85 kg**

produced since 10.2004 till 03.2008

Approval number according to Directive 94/20/EC: **e20\*94/20\*0805\*00**

## Foreword

This towing hitch is designed according to rules of safety traffic regulations. The towing hitch is a safety component and can be install only by qualified personnel. Any alteration or conversion of the towing hitch is prohibited and would lead to cancellation of design certification. Remove insulating compound and underseal from vehicle (if present) in the areas of the matting surfaces of the towing hitch. The vehicle manufacturer's specifications regarding trailer load and max. vertical cup mass are decisive for driving whereat values for the towing hitch cannot be exceeded.

*D-value formula:*

$$\frac{\text{Max trailer weight [kg]} \times \text{Max vehicle weight [kg]}}{\text{Max trailer weight [kg]} + \text{Max vehicle weight [kg]}} \times \frac{9,81}{1000} = D \text{ [kN]}$$