

## FITTING INSTRUCTION

Clamp mark in acc. with		Cables joining
ISO	PN	
1	L	Left directional lights
2	+	Rear fog lights
3	31	Ground
4	R	Right directional lights
5	58R	Right side parking lights
6	54	Stoplights
7	58L	Left side parking lights

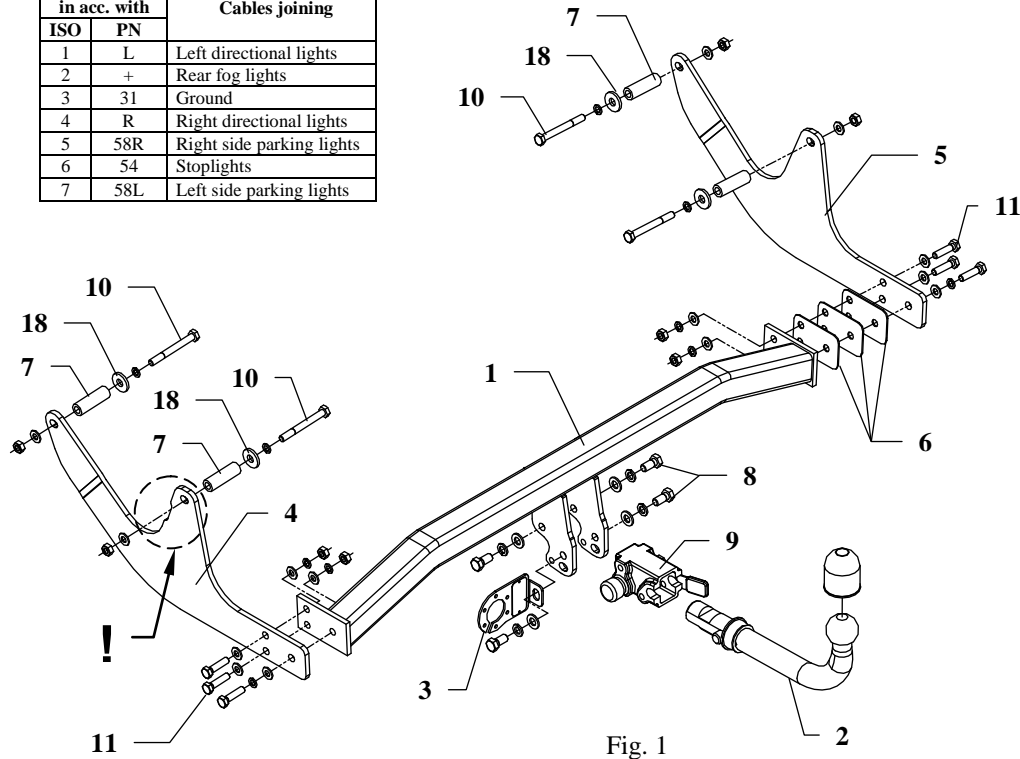

Fig. 1

This towing hitch is designed to assembly in following car: **DACIA LOGAN ESTATE** produced since 2007 till 2013, catalogue number **G51A** and is prepared to tow trailers max total weight up to **1300 kg** and max vertical load **75 kg**.

### *From manufacturer*

Thank you for buying our product. Their reliability has been confirmed in many tests. Reliability of towing hitch depends also on correct assembly and right exploit. For this reasons we kindly ask to read carefully this instruction and apply to hints.

*The towing hitch should be install in points described by a car producer.*

## The instruction of the assembly

1. Disassemble a spare wheel unit and remove a muffler from a last rubber handle.
2. Find plugged holes into chassis' members underneath the car (two per each side). Remove plugs.
3. To holes (from inside) put distance sleeves (pos. 7) with big washers (pos. 18) and bolts M10x90mm (pos. 10) as shown on the drawing 2.
4. From below the car, on protruding bolts M10 put side brackets pos. 4 and 5. Twist loosely.
5. Between mounted side brackets put main bar of the towing hitch (pos. 1) and fix with bolts M10x40mm (pos. 11) according to figure 1. Remember about fish-plates (pos. 6) on the right side!
6. Tighten all bolts according to the torque show in the table.
7. Fix body of the automat (pos. 9) and the socket plate (pos. 3) using bolts M12x25mm (pos. 8) from accessories. Place tow-ball (pos. 2) according to supplied instruction.
8. Connect electric wires of 7-pole socket according to the instruction of the car. (Recommended to make at authorized service station)
9. Complete paint layer damaged during installation.

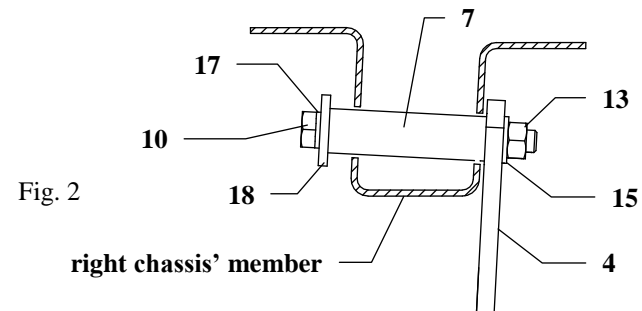

Fig. 2

right chassis' member

Torque settings for nuts and bolts (8,8):	
<b>M 8</b> - 25 Nm	<b>M 10</b> - 55 Nm
<b>M 12</b> - 85 Nm	<b>M 14</b> - 135 Nm











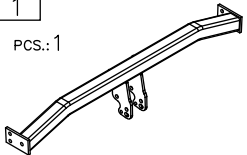
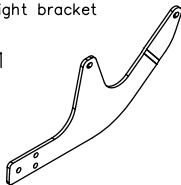
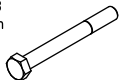





### NOTE

After install the towing hitch you should get adequate note in registration book (at authorised service station).The car should be equipped with:

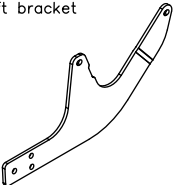
- Indicators
- Tow mirrors

After 1000km of exploitation check all bolts and nuts. The ball of towing hitch must be always kept clear and conserve with a grease.

## Towing hitch accessories:

Pos. 1 Main bar PCS.: 1 	Pos. 5 Right bracket PCS.: 1 	Pos. 10 Bolt 8,8 B M10x90mm PCS.: 4 	Pos. 16 Spring washer ø12mm PCS.: 4 
Pos. 2 Tow ball PCS.: 1 	Pos. 6 Fish-plate 95x60x2 PCS.: 3 	Pos. 11 Bolt 8,8 B M10x40mm PCS.: 6 	Pos. 17 Spring washer ø10mm PCS.: 10 
Pos. 3 Socket's plate PCS.: 1 	Pos. 7 Distance sleeve ø20x4mm L=61mm PCS.: 4 	Pos. 12 Body's plug PCS.: 1 	Pos. 18 Washer ø32xø12x4mm PCS.: 4 
Pos. 4 Left bracket PCS.: 1 	Pos. 8 Bolt 8,8 B M12x25mm PCS.: 4 	Pos. 13 Nut 8 B M10 PCS.: 8 	Pos. 19 Ball's cover PCS.: 1 
	Pos. 9 Body of the automat PCS.: 1 	Pos. 14 Plain washer ø12mm PCS.: 4 	
		Pos. 15 Plain washer ø10mm PCS.: 14 	



**PPUH AUTO-HAK S.J.**

Produkcja Zaczepów Kulowych  
Henryk & Zbigniew Nejman  
76-200 SŁUPSK ul. Słoneczna 16K  
tel/fax (059) 8-414-414; 8-414-413  
E-mail: office@autohak.com.pl  
www. autohak.com.pl

## Towing hitch (without electrical set)

Class: **A50-X** Cat. no. **G51A**

Designed for:

Manufacturer: **DACIA**

Model: **LOGAN**

Type: **Estate**

produced since 2007 till 2013

Technical data:

**D-value: 7,8 kN**

maximum trailer weight: **1300 kg**

maximum vertical cup load: **75 kg**

Approval number according to Directive 94/20/EC: **e20\*94/20\*0286\*00**

## Foreword

This towing hitch is design according to rules of safety traffic regulations. The towing hitch is a safety component and must be installed only by qualified personnel. Any alteration or conversion to the towing hitch is prohibited and would lead to cancellation of design certification. Remove insulating compound and underseal from vehicle (if present) in the area of the matting surfaces of the towing hitch.

The vehicle manufacturer's specifications regarding trailer load and max. vertical cup load are decisive for driving, and values for the towing hitch must not be exceeded.

*D-value formula:*

$$\frac{\text{Max trailer weight [kg]} \times \text{Max vehicle weight [kg]}}{\text{Max trailer weight [kg]} + \text{Max vehicle weight [kg]}} \times \frac{9,81}{1000} = D \text{ [kN]}$$