

## FITTING INSTRUCTION

Clamp mark in acc. with		Cables joining
ISO	PN	
1	L	Left directional lights
2	+	Rear fog lights
3	31	Ground
4	R	Right directional lights
5	58R	Right side parking lights
6	54	Stoplights
7	58L	Left side parking lights

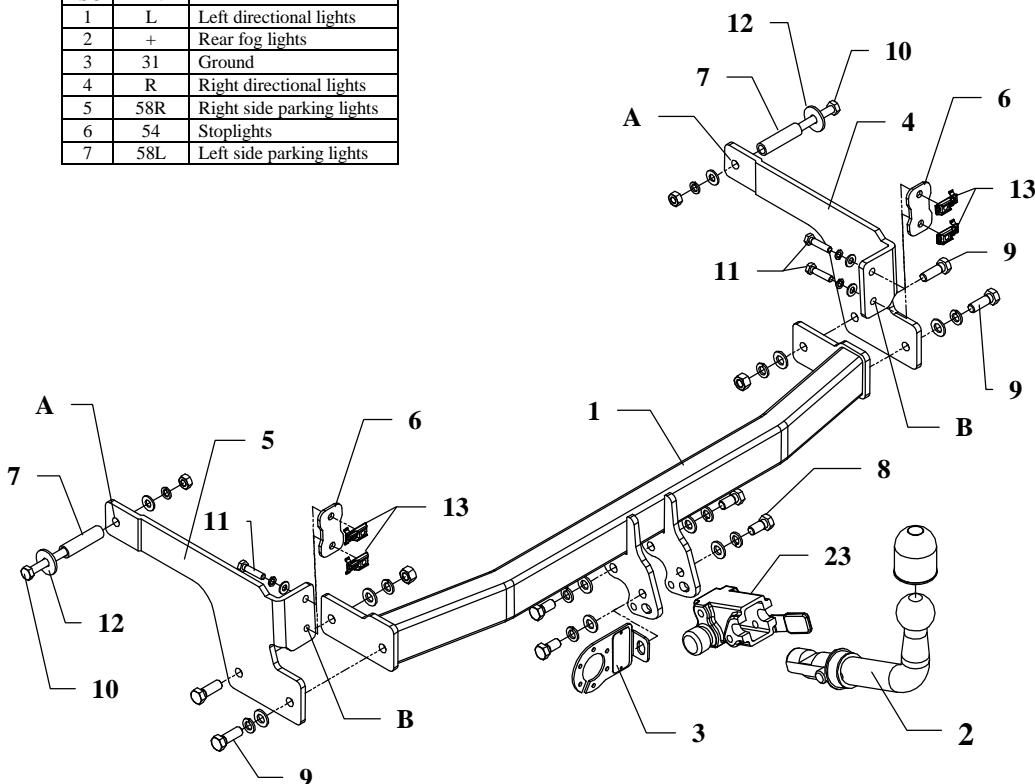

This towbar is designed to assembly in following cars:  
**RENAULT LAGUNA 5 doors**, produced since 2001 till 2007, catalogue no.**G39A** and is prepared to tow trailers max total weight **1500 kg** and max vertical load **75 kg**.

### *From manufacturer*

Thank you for buying our product. Their reliability has been confirmed in many tests. Reliability of towbar depends also on correct assembly and right operation. For this reasons we kindly ask to read carefully this instruction and apply to hints.

*The towbar should be install in points described by a car producer.*

## The instruction of the assembly

- Underside the car (in the rear panel) find plugged holes on the right and left side, then make them available and put in "Caged nut" M8-pos. 13
- Disassemble a plastic cover
- Put distance sleeves (pos. 7) through the fabric chassis members holes (do it outside the chassis)
- Fix side brackets (pos. 4 and 5) through holes A with bolts M10x100mm (pos. 10) and through holes B by bolts M8x35mm (pos. 9) to the car chassis.  
**Attention!** Put fish-plates (pos. 6) between brackets (pos. 4 and 5) at points B and body of the car.
- Slide main bar of the towbar (pos. 1) between installed brackets (pos. 4 and 5) and fix it with bolts M12x35mm (pos. 9)
- Tighten all nuts and bolts according to the torque shown in the table
- Reassemble the plastic cover.
- Fix body of the automat (pos. 23) and the socket plate (pos. 3) using bolts M12x25mm (pos. 8) from accessories. Place tow-ball (pos. 2) according to supplied instruction.
- Connect the electric wires according to the instructions of the car
- Complete the paint cover of towbar (during the mounting paint cover could be destroyed).

Torque settings for nuts and bolts (8,8):

<b>M6</b> - 11 Nm	<b>M8</b> - 25 Nm	<b>M10</b> - 50 Nm
<b>M12</b> - 87 Nm	<b>M14</b> - 138 Nm	<b>M16</b> - 210 Nm











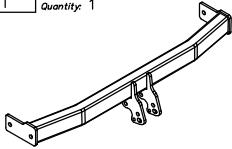











### NOTE

After install the towbar you should get adequate note in registration book (at authorised service station). The car should be equipped with:

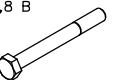
- Indicators
- Tow mirrors

After 1000km of exploitation check all bolts and nuts. The ball of towbar must be always kept clear and conserve with a grease.

## Towbar accessories:

Pos. 1 Name: Main bar Quantity: 1 	Pos. 6 Name: Fish-plate Quantity: 2 	Pos. 12 Name: Washer Quantity: 2 Dim.: $\phi 35 \times \phi 12 \times 3 \text{ mm}$ 	Pos. 18 Name: Plain washer Quantity: 4 Dim.: $\phi 8,5 \text{ mm}$ 
Pos. 2 Name: Tow ball Quantity: 1 	Pos. 7 Name: Distance sleeve Quantity: 2 Dim.: $\phi 17 \times 2 \text{ mm}$ L=64mm 	Pos. 13 Name: Capet nut Quantity: 4 Dim.: M8 	Pos. 19 Name: Spring washer Quantity: 8 Dim.: $\phi 12,2 \text{ mm}$ 
Pos. 3 Name: Socket plate Quantity: 1 	Pos. 8 Name: Bolt 8,8 B Quantity: 4 Dim.: M12x25mm 	Pos. 14 Name: Nut 8 B Quantity: 2 Dim.: M12 	Pos. 20 Name: Spring washer Quantity: 2 Dim.: $\phi 10,2 \text{ mm}$ 
Pos. 4 Name: Right bracket Quantity: 1 	Pos. 9 Name: Bolt 8,8 B Quantity: 4 Dim.: M12x35mm 	Pos. 15 Name: Nut 8 B Quantity: 2 Dim.: M10 	Pos. 21 Name: Spring washer Quantity: 4 Dim.: $\phi 8,2 \text{ mm}$ 
Pos. 5 Name: Left bracket Quantity: 1 	Pos. 10 Name: Bolt 8,8 B Quantity: 2 Dim.: M10x100mm 	Pos. 16 Name: Plain washer Quantity: 8 Dim.: $\phi 13 \text{ mm}$ 	Pos. 22 Name: Ball cover Quantity: 1 
	Pos. 11 Name: Bolt 8,8 B Quantity: 4 Dim.: M8x35mm 	Pos. 17 Name: Plain washer Quantity: 2 Dim.: $\phi 10,5 \text{ mm}$ 	Pos. 23 Name: Body of the automat Quantity: 1 



**PPUH AUTO-HAK Sp. J.**

Produkcja Zaczepów Kulowych  
Henryk & Zbigniew Nejman  
76-200 SŁUPSK ul. Słoneczna 16K  
tel./fax (059) 8-414-414; 8-414-413  
E-mail: [office@autohak.com.pl](mailto:office@autohak.com.pl)  
[www.autohak.com.pl](http://www.autohak.com.pl)

## Towing hitch (without electrical set)

Class: **A50-X** Cat. no. **G39A**

Designed for:

Manufacturer: **RENAULT**

Model: **LAGUNA**

Type: **5 doors**

produced since 2001 till 2007

Technical data:

**D-value: 8,15 kN**

maximum trailer weight: **1500 kg**

maximum vertical cup load: **75 kg**

Approval number according to Directive 94/20/EC: **e20\*94/20\*1051\*00**

## Foreword

This towbar is designed according to rules of safety traffic regulations. The towing hitch is a safety component and can be install only by qualified personnel. Any alteration or conversion of the towing hitch is prohibited and would lead to cancellation of design certification. Remove insulating compound and underseal from vehicle (if present) in the area of the matting surfaces of the towing hitch. The vehicle manufacturer's specifications regarding trailer load and max. vertical cup load are decisive for driving, and values for the towing hitch cannot be exceeded.

*D-value formula:*

$$\frac{\text{Max trailer weight [kg]} \times \text{Max vehicle weight [kg]}}{\text{Max trailer weight [kg]} + \text{Max vehicle weight [kg]}} \times \frac{9,81}{1000} = D \text{ [kN]}$$